

## HX-D016

### D016 WIFI led controller for LED RGBW Strips

Controller adopts the most advanced PWM (Pulse Width Modulation) digital control technology, it is used for controlling constant voltage LED RGBW lamps. For instance, point source of light, flexible light strip, led modules, led strings and so on. Can be controlled by both RF 2.4GHz remote control and WIFI APP, the WIFI control technology powered by Tuya.



### Product Features

- Short-circuit protection.
- DC12-24V, four channels output, Max. load current: 4CH\*4A; Max. load power: 192W/12V; 384W/24V.
- RF remote control is optional, 3 compatible remote controls for options.
- WIFI technology powered by Tuya, And compatible with voice control via Amazon Alexa, Google Assistant, Yandex Alice and so on..
- Wireless-synchronization function under remote controlled type.

- Memory function, each time power-on reserve the mode which stop in the last power-off.
- Warranty of this product is three years, exclude the artificial situation of damaged or overload working.

## Technical Parameters

### Controller

Working temperature	-20-60°C	Supply voltage	DC12V-24V
Static power consumption	<1W	Connecting mode	Common anode
Grayscale	1024 levels	Speed stage	100 levels
External dimension	L70*W40*H20 mm	Packing size	L95*W47*H33mm
Net weight	65g	Gross weight	80g
RF frequency	2.4GHz	RF distance	≤20m
Short circuit protection	Yes	Memory function	Yes
Output	4 channels	Output current	≤4A(each channel)
PWM frequency	1.95KHz	Max. Output power	12V:<192W, 24V:<384W

### Dimensions

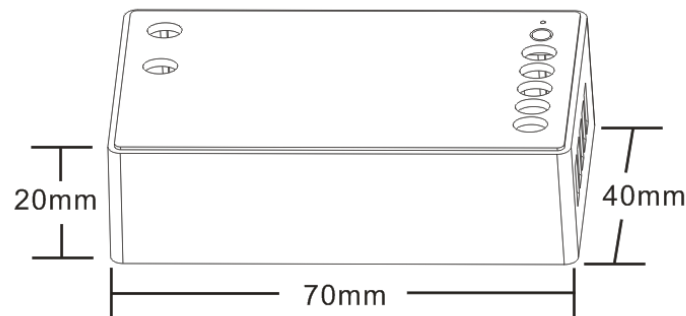

### Interface Specifications

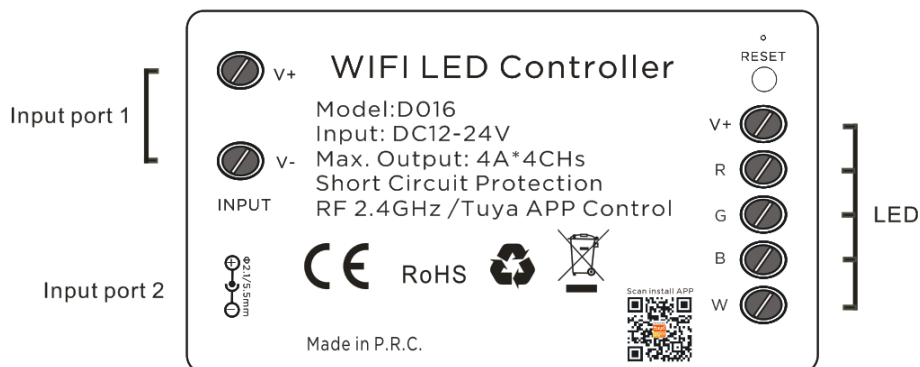

### Direction for use





1) WIFI controlled by Tuya Application to achieve smart control like group control, scene control, timer control, music control and so on.

Scan QR code from controller to download Tuya application:  (Tuya).

Long pressing "Reset" button on controller and hold for 5 seconds until the loading LEDs flashing to start the connection with Tuya APP. Please read operation instruction of App, or following the pop-up prompt message with the APP, to finish the rest connection operation.

And compatible with voice control via Amazon Alexa, Google Assistant, Yandex Alice and so on.

**2) Remote controlled by RF 2.4GHz remote control as below:**

Option 1(1 zone)	Option 2(4 zone)	Option 3 (1 zone)	Option 4 (1 zone)
			
SWC-RGBW-2.4G	RFBK-RGB-2.4G(RGBW function)	RFBT02A(RGBW function)	HWP86-RGBW-2.4G

Please pair the WIFI controller to remote control before using. The operation instruction and functions can be found from manuals of remote control.

**Wireless-synchronization function under remote controlled type**

Receivers will transmit the control signals from the remote control and self-inspection the work statuses for each other, so multiple receivers can wireless-sync-work completely when be paired to the same one remote control, not only static mode but also dynamic mode, to achieve wired-like operation experience.

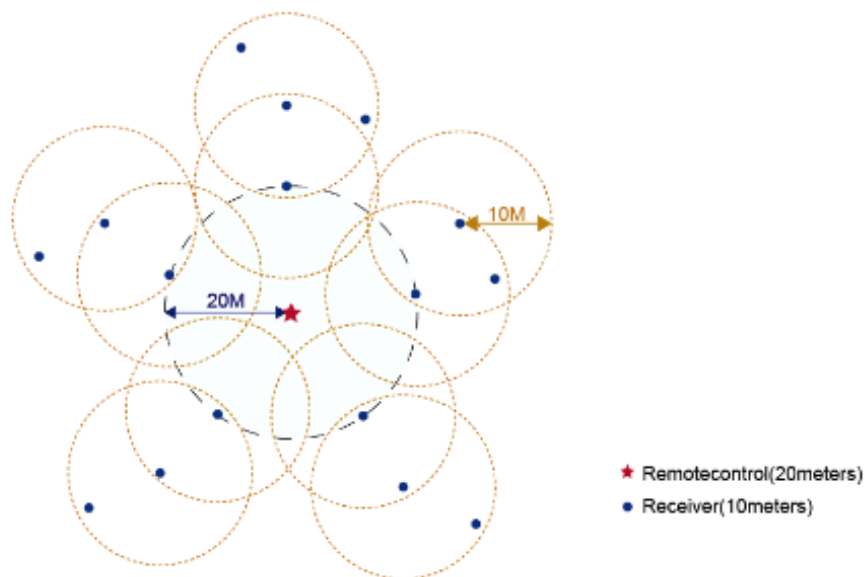

In order to achieve perfect wireless synchronization effect, please keep the distance between receivers within 10 meters as above show.

**The function of each remote as below:**

**A. SWC-RGBW-2.4G**

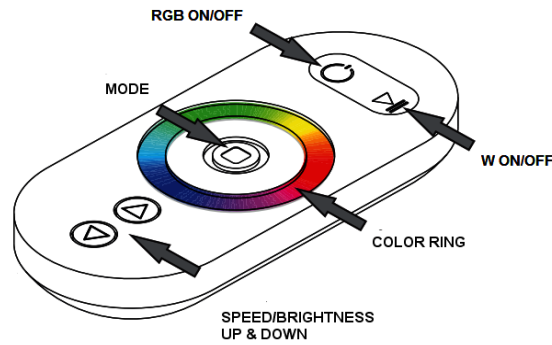

The function of each button as below:

Name of key	Instruction	Remarks
<b>RGB ON/OFF</b>	ON/OFF key for RGB channels	
<b>W ON/OFF</b>	ON/OFF key for CW/WW channel	
<b>Mode</b>	The mode will go to next, when you touch the key each time	9 modes in total.
<b>Speed/Brightness +</b>	The Speed/Brightness will +1, when touch the key each time	Speed for dynamic modes, Brightness for static modes .
<b>Speed/Brightness -</b>	The Speed/Brightness will -1, when touch the key each time	
<b>Color Ring</b>	For RGB channels static color selection	

9 modes in total as below:

No	Patterns	No	Patterns
<b>1</b>	Static white	<b>6</b>	Seven-color gradient changing
<b>2</b>	White breath	<b>7</b>	R/G cross fade
<b>3</b>	Three-color jump changing	<b>8</b>	R/B cross fade
<b>4</b>	Seven-color jump changing	<b>9</b>	G/B cross fade
<b>5</b>	Three-color gradient changing		

### B. RFBK-RGB-2.4G(RGBW function)

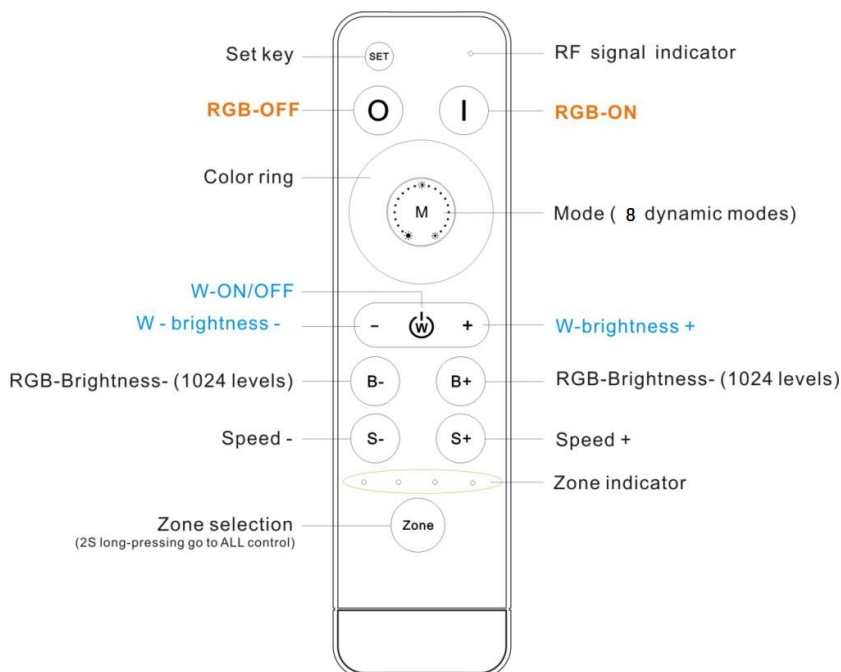



Name	Description
SET	Nonfunctional.
I	RGB channels-Turn on.
O	RGB channels-Turn off.
<b>Color ring</b>	Static color options, 64 colors in total.
M	Dynamic modes, 8 modes in total.
⏻	W channel-Turn ON/OFF.
-	W channel- brightness -, 1024 levels, long-press can get fast adjusting.
+	W channel- brightness +, 1024 levels, long-press can get fast adjusting.
B-	Brightness - for RGB static colors by 1024 levels. Long-press get fast adjusting.
B+	Brightness + for RGB static colors by 1024 levels. Long-press get fast adjusting.
S-	Speed down for dynamic mode (100 levels). Long-press get fast adjusting.
S+	Speed up for dynamic mode (100 levels). Long-press get fast adjusting.
Zone	Zone selection, 2 seconds long-press get "all-control".

### 8 dynamic modes as below:

No	Patterns	Remarks	No	Patterns	Remarks
1	White breathe	Speed is adjustable, brightness is unadjustable	5	7 color fade	Speed is adjustable, brightness is unadjustable
2	3 color jumpy		6	R/G cross fade	
3	7 color jumpy		7	R/B cross fade	
4	3 color fade		8	G/B cross fade	

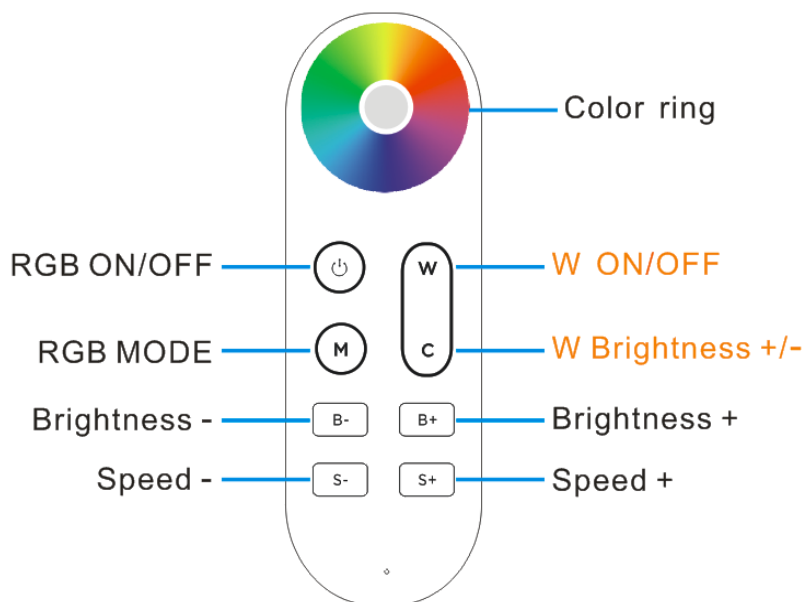
### C.RFBT02A(RGBW function)



Name key	of	Description
		RGB channels ON/OFF in any time
		RGB channels Static color options, 64 colors in total.

<b>M</b>	RGB channels Dynamic modes, 8 modes in total.
<b>W</b>	W channel: Turn ON/OFF
<b>C</b>	W channel: Brightness +/-, 1024 levels, long-press can get fast adjusting.
<b>B-</b>	Brightness - for static colors by 1024 levels. Long-press can get fast adjusting.
<b>B+</b>	Brightness + for static colors by 1024 levels. Long-press can get fast adjusting.
<b>S-</b>	Speed down for dynamic mode (100 levels). Long-press can get fast adjusting.
<b>S+</b>	Speed up for dynamic mode (100 levels). Long-press can get fast adjusting.

Tips: RGB channels and W channel are controlled independently.

### 8 dynamic modes as below:

No	Patterns	Remarks	No	Patterns	Remarks
1	White breathe	Speed is adjustable, brightness is unadjustable	5	7 color fade	Speed is adjustable, brightness is unadjustable
2	3 color jumpy		6	R/G cross fade	
3	7 color jumpy		7	R/B cross fade	
4	3 color fade		8	G/B cross fade	

### D. HWP86-RGBW-2.4G

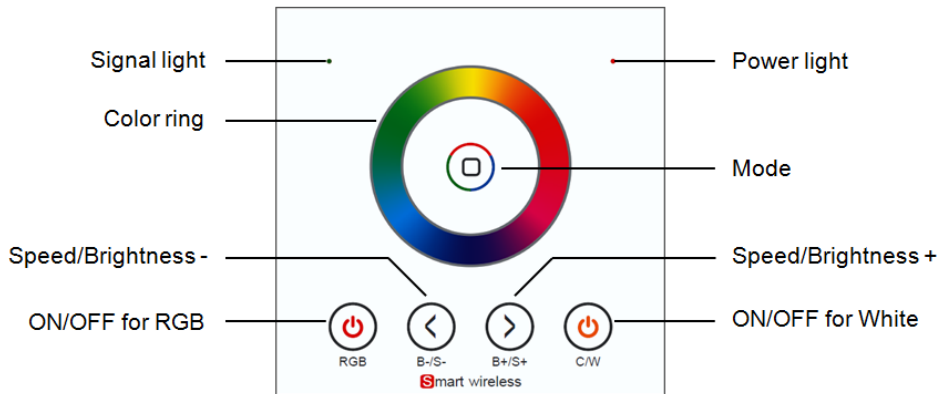

The function of each button as below:

Name of key	Instruction	Remarks
<b>RGB</b>	ON/OFF key for RGB channels	
<b>C/W</b>	ON/OFF key for CW/WW channels	
<b>Mode</b>	The mode will go to next, when you touch the key each time	9 modes in total.
<b>Speed/Brightness +</b>	The Speed/Brightness will +1, when touch the key each time	Speed for dynamic modes, Brightness for static modes .
<b>Speed/Brightness -</b>	The Speed/Brightness will -1, when touch the key each time	
<b>Color Ring</b>	For RGB channels static color selection	

9 modes in total as below:

No	Patterns	No	Patterns
1	Static white	6	Seven-color gradient changing
2	White breath	7	R/G cross fade
3	Three-color jump changing	8	R/B cross fade
4	Seven-color jump changing	9	G/B cross fade
5	Three-color gradient changing		

### Typical Applications

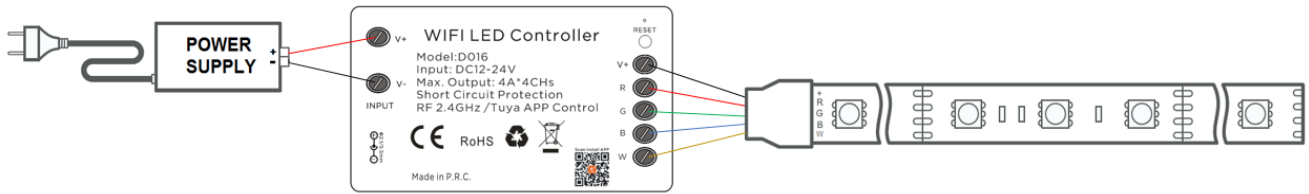

Product information for placing order

Product name	Item number
D016 series WIFI led controller for RGBW	<b>WIFI controller: D016</b> <b>Remote control(optional):</b> HX-SWC-RGBW-2.4G HX-RFBK-RGB-2.4G HX-HWP86-RGBW-2.4G HX-RFBT02A